

# Accuphase

*CLASS-A STEREO POWER AMPLIFIER*

## *A-20V*

● Pure Class-A operation delivers quality power: 20 watts x 2 into 8 ohms ● Power MOS-FET output stage features 3-parallel push-pull configuration and delivers linear power even into extremely low-impedance loads ● Current feedback design combines superb sound quality with totally stable operation ● Bridged mode allows use as a monaural amplifier ● Balanced inputs ● Heavy-duty speaker terminals





**Pure Class-A goes straight for the heart of the music. The output stage uses power MOS-FET devices arranged in a triple parallel configuration for each channel. Ultra-linear power progression reaches down to very low impedance loads: 80 watts  $\times$  2 into 2 ohms. Current feedback topology assures stability and creates an utterly convincing sound stage. Gain control makes the amplifier perfectly suited also for use as midrange/high-range amplifier in a multi-amplifier system.**

Accuphase power amplifiers are designed to realize two major goals: very low output impedance (Note 1), and constant drive voltage (Note 2). As a result, Accuphase amplifiers are capable of driving any kind of speaker load with optimum results, which is one of the reasons for the high praise that these products invariably receive. The low impedance not only ensures accurate speaker drive but also absorbs the counter electromotive force generated by the voice coil, thereby eliminating a major source of intermodulation distortion. The overall result is a significant improvement in sound quality.

The A-20V is a pure class-A amplifier which fully implements these advanced circuit design principles. Another advantage is the use of power MOS-FET devices for further enhanced sonic definition. In a pure class-A amplifier, the power supply delivers a constant amount of power regardless of the presence or absence of a music signal. This means that the amplifier remains unaffected by fluctuations in voltage and other external influences. As a consequence of this design, the output stage produces considerable amounts of thermal energy, but in the A-20V this is dissipated by extra-large heat sinks, to eliminate the possibility of problems caused by internal heat build-up.

The power MOS-FETs used in the output stage are renowned for their superior sound and high reliability. Because they exhibit negative thermal characteristics, there is no danger of thermal "runaway" as exists with bipolar transistors. Three pairs of these devices are arranged in a parallel push-pull configuration for each channel. The result is stable operation with ideal power linearity even down to ultra-low impedances.

The current feedback principle developed by Accuphase requires only minimal amounts of negative feedback to ensure outstanding phase characteristics in the upper frequency range. This approach combines operation stability with excellent frequency response. A gain control is provided which operates by modifying the NFB amount. This is useful for example in multi-amp systems where even minimal amounts of noise in the medium and high frequency bands could be a problem.

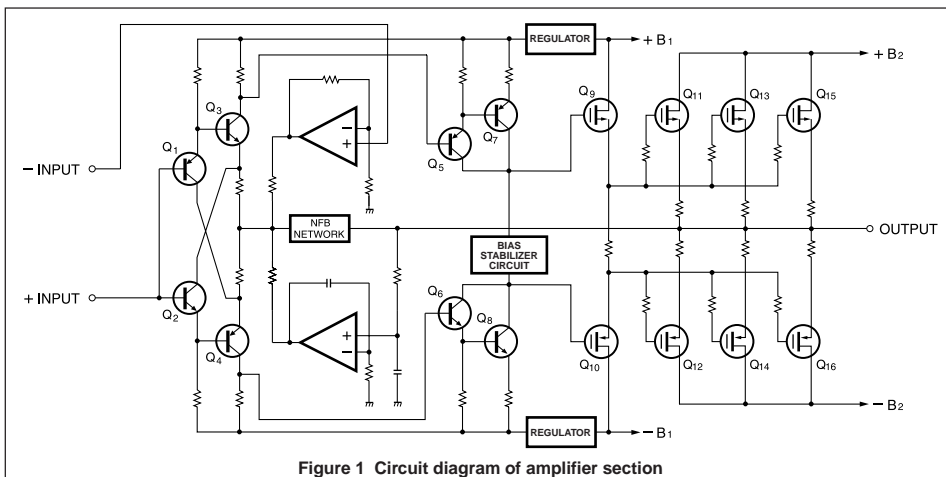

Figure 1 Circuit diagram of amplifier section

**Note 1 Low amplifier output impedance**

The load of a power amplifier, namely the loudspeaker, generates a counter-electromotive force that can flow back into the amplifier via the NF loop. This phenomenon is influenced by fluctuations in speaker impedance, and interferes with the drive performance of the amplifier. The output impedance of a power amplifier should therefore be made as low as possible by using output devices with high current capability.

**Note 2 Constant drive voltage principle**

Even in the presence of a load with wildly fluctuating impedance, the ideal power amplifier should deliver a constant voltage signal to the load. When the supplied voltage remains constant for any impedance, output power will be inversely proportional to the impedance of the load. A conventional amplifier can easily be made to operate in this way down to a load impedance of about 4 ohms. However, at 2 ohms and below much more substantial output reserves will be needed, which can only be sustained by an extremely well designed and capable output stage and a highly robust and powerful power supply section. To build such an amplifier is a task that requires not only considerable experience and resources, but also a thorough reappraisal of basic tenets.

**Power MOS-FET output stage with two units in 3-parallel push-pull configuration delivers 80 watts into 2 ohms, 40 watts into 4 ohms, or 20 watts into 8 ohms with outstanding linearity**

The output stage (Figure 1) uses power MOS-FETs with negative thermal characteristics. Three pairs of these devices are arranged in a parallel push-pull configuration for each channel. The result is stable operation with ideal power linearity even down to ultra-low impedances. The parallel connection cancels out impedance differences of individual devices, thereby minimizing residual noise. It also allows using the MOS-FETs in their

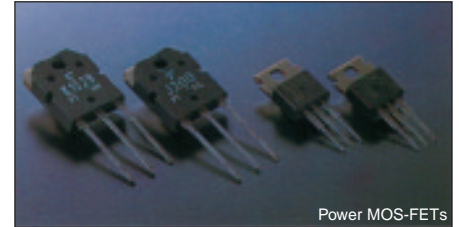

Power MOS-FETs

most linear low-power range, which further contributes to sound quality.

Figure 2 shows the output voltage/current characteristics at various load impedances. Output voltage is almost constant at various loads, meaning that current increases linearly. Actual measurements of clipping power have yielded the following figures, which impressively demonstrate the more than ample performance of the A-20V: 1 ohm: 156 watts, 2 ohms: 126 watts, 4 ohms: 85 watts, 8 ohms: 50 watts.

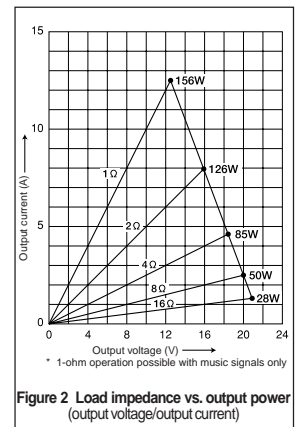

Figure 2 Load impedance vs. output power (output voltage/output current)

**Current feedback topology prevents phase shifts**

The amplifying circuits in the A-20V use the current feedback principle for negative feedback. At the input point of the feedback loop, the impedance is kept low and current detection is performed. A trans-impedance amplifier then converts the current into a voltage to be used as the feedback

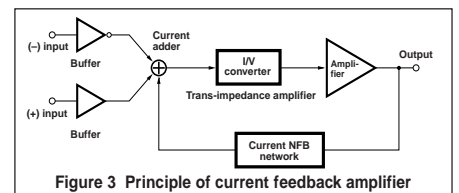

Figure 3 Principle of current feedback amplifier

signal. Since the impedance at the current feedback point (current adder in Figure 3) is very low, there is almost no phase shift. Phase compensation therefore can be kept at a minimum. A minimal amount of NFB results in maximum improvement of circuit parameters. The result is excellent transient response and superb sonic transparency, coupled with utterly natural energy balance.

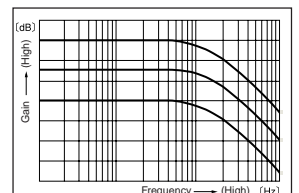

Figure 4 Frequency response with current feedback (response remains uniform also when gain changes)



Figure 4 shows frequency response for different gain settings of the current feedback amplifier. The graphs demonstrate that response remains uniform over a wide range.

#### NFB switching type gain control

The current feedback principle, which ensures low phase shift and high stability, allowed the designers to implement a gain control (-3 dB, -6 dB, -9 dB, -12 dB) which operates by altering the NFB amount. Consequently, when gain is lowered the noise floor also becomes lower, a desirable characteristic especially when driving highly efficient speakers. It also is advantageous when using the A-20V as the midrange/high-range unit in a multi-amplified system where separate amplifiers drive the individual speaker units.



#### Robust power supply with large power transformer and high filtering capacity

In any amplifier, the power supply plays a vital role since it acts as the original source for the output delivered to the speaker. The A-20V, in spite of its conservative 20 W/8 ohms x 2 rating, employs a large 400 VA power transformer housed in an enclosure filled with vibration-damping material. Two electrolytic capacitors, specially selected for their sonic properties and each rated for 47,000 µF, provide ample filtering capacity for the rectified current. The capacitors feature an elastic soft coating which helps to make



them impervious to the detrimental influence of vibrations.

#### Bridged operation mode creates a true monophonic amplifier with 160 watts into 4 ohms or 80 watts into 8 ohms

Bridged mode means that the two channels of an amplifier are driven with the same signal voltage but with opposite phase, and their output is combined. The A-20V provides a switch arrangement for bridged operation, which turns the unit into a high-grade monaural amplifier capable of delivering a full 160 watts into 4 ohms or 80 watts into 8 ohms.

#### Balanced connection reliably blocks induced noise

Balanced signal transmission means that the output stage of a component supplies two signal lines which have identical voltage but opposite phase. Since any noise interference that has arisen during transmission will be present in both lines with identical phase, such noise can be canceled out, leaving only the pure original signal. Even with long cable runs, the balanced connection principle keeps the signal transfer completely free from any kind of interference.

#### Large analog power meters

The large power meters have a peak hold function which lets the user easily monitor the output level of the rapidly fluctuating music signal. Thanks to logarithmic compression, the meters cover a wide dynamic range. A switch for meter operation and illumination control is also provided.

- Power amplifier assembly with 3 parallel push-pull MOS-FETs (total 6 devices for left and right channel) and current feedback amplifier circuitry mounted directly to massive aluminum diecast heat sinks

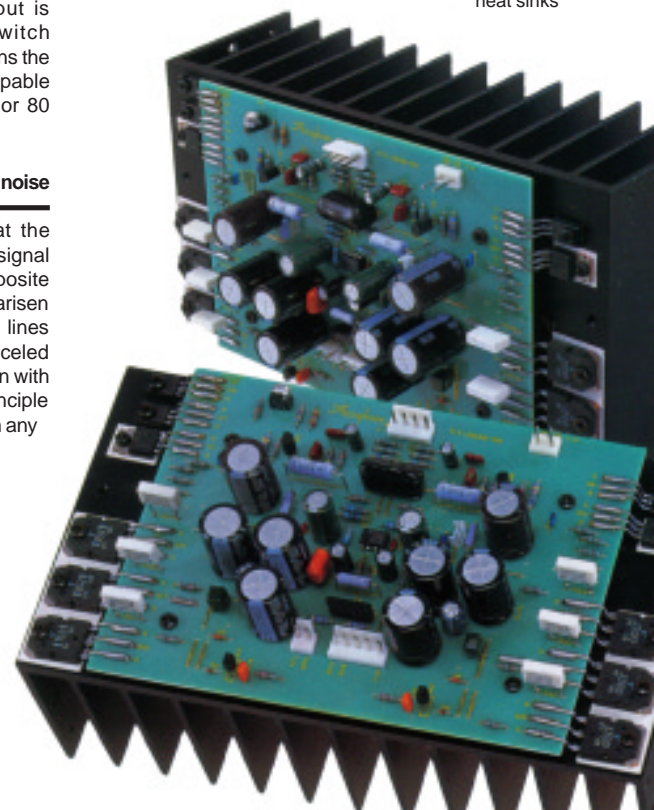

## Major signal paths gold-plated

High-purity copper is commonly used in audio components for signal path lines. The A-20V goes one step further by providing gold-plating for printed circuit board traces as well as for the input jacks and speaker terminals. This approach results in a distinct sonic improvement.

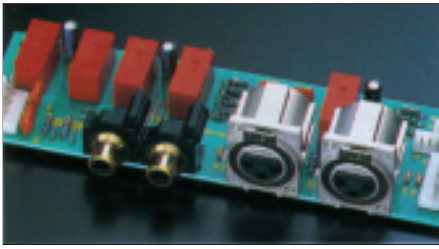

Unbalanced connectors and balanced inputs

## Extra-large speaker terminals

The oversize speaker terminals accommodate even very heavy-gauge speaker cable. The terminals are made of extruded high-purity brass and are gold-plated for utmost reliability and minimum contact resistance. Molded caps are provided to assure proper insulation.



## Easy switching between dual mono operation and bridged connection

A mode selector makes it simple to switch between dual mono, stereo, or bridged operation. The dual

mono position is useful for example to drive a center woofer in mono, or to obtain the same signal from both speaker outputs for driving a bi-amped speaker setup with separate amplifiers for the low and high frequency range.

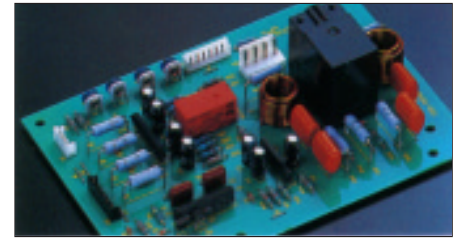

Assembly with protection circuitry, etc.

## FRONT PANEL

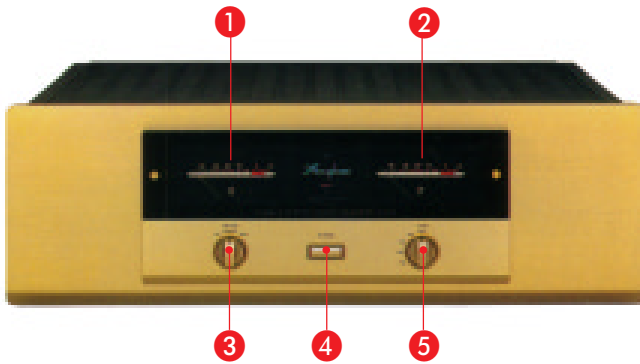

## REAR PANEL

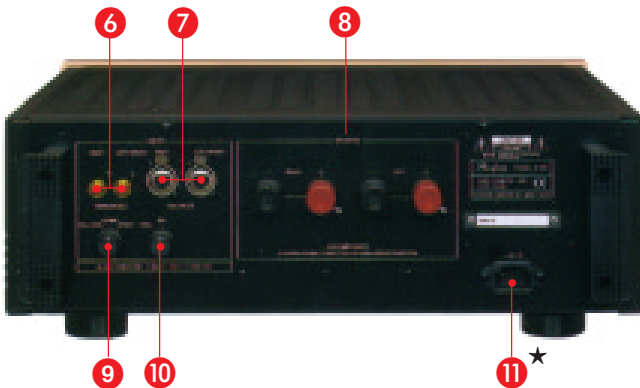

- |  |  |
|--|--|
| <p>① Left-channel power meter (dB scale)<br/>                 ② Right-channel power meter (dB scale)<br/>                 ③ Power METER OFF switch and range selector<br/>                 OFF NORMAL -20 dB<br/>                 ④ POWER switch<br/>                 ⑤ GAIN selector<br/>                 MAX -3 dB -6 dB -9 dB -12 dB<br/>                 ⑥ Unbalanced inputs</p> | <p>⑦ Balanced inputs<br/>                 ① GND ② Inverted (-)<br/>                 ③ Non-inverted (+)<br/>                 ⑧ Left/right channel speaker output terminals<br/>                 ⑨ Mode selector<br/>                 DUAL MONO NORMAL BRIDGE<br/>                 ⑩ Input selector<br/>                 UNBALANCED BALANCED<br/>                 ⑪ AC input connector (for supplied power cord) *</p> |
|--|--|

### Remarks

- \* This product is available in versions for 120/230 V AC. Make sure that the voltage shown on the rear panel matches the AC line voltage in your area.
- \* The shape of the AC inlet and plug of the supplied power cord depends on the voltage rating and destination country.

- Specifications and design subject to change without notice for improvements.

## A-20V Guaranteed Specifications

[Guaranteed specifications are measured according to the EIAJ standard RS-490]

● <b>Continuous Average Output Power (20 - 20,000 Hz)</b>	
Stereo operation (both channels driven)	80 watts per channel into 2 ohms 40 watts per channel into 4 ohms 20 watts per channel into 8 ohms
Monophonic operation (bridged connection)	160 watts into 4 ohms 80 watts into 8 ohms
● <b>Total Harmonic Distortion</b>	
Stereo operation (both channels driven)	0.05%, with 2-ohm load 0.02%, with 4 to 16 ohms load
Monophonic operation (bridged connection)	0.02%, with 4 to 16 ohms load
● <b>Intermodulation Distortion</b> 0.003%	
● <b>Frequency Response</b>	
At rated output : 20 - 20,000 Hz +0, -0.2 dB At 1 watt output : 0.5 - 160,000 Hz +0, -3.0 dB	
● <b>Gain (GAIN selector in MAX position)</b> 28.0 dB (in stereo and monophonic operation)	
● <b>Output Load Impedance</b>	
Stereo operation : 2 to 16 ohms Monophonic operation : 4 to 16 ohms	
● <b>Damping Factor</b>	
Stereo operation : 120 Monophonic operation : 60	
● <b>Input Sensitivity (with 8-ohm load)</b>	
Stereo operation 0.50 V for rated output 0.11 V for 1 watt output	
Monophonic operation 1.00 V for rated output 0.11 V for 1 watt output	
● <b>Input Impedance</b>	
Balanced : 40 kilohms Unbalanced : 20 kilohms	
● <b>Signal-to-Noise Ratio (A-weighted)</b> 110 dB with input shorted, at rated output	
● <b>Output Level Meters</b>	
NORMAL : -40 to +3 dB and direct watt reading -20dB : -60 to -17 dB and direct watt reading With logarithmic compression and on/off switch	
● <b>Power Requirements</b>	
120V/230V (Voltage as indicated on rear panel) AC, 50/60Hz	
● <b>Power Consumption</b>	
160 watts idle 250 watts in accordance with IEC-65	
● <b>Maximum Dimensions</b>	
Width 475 mm (18-11/16") Height 170 mm (6-11/16") Depth 426 mm (16-3/4")	
● <b>Weight</b>	
22.6 kg (49.8 lbs) net 27.0 kg (59.5 lbs) in shipping carton	